

Decorative Curtain Poles



 SilentGliss

Hand Operated Curtain Pole System

Silent Gliss® 6130M Metropole 30mm

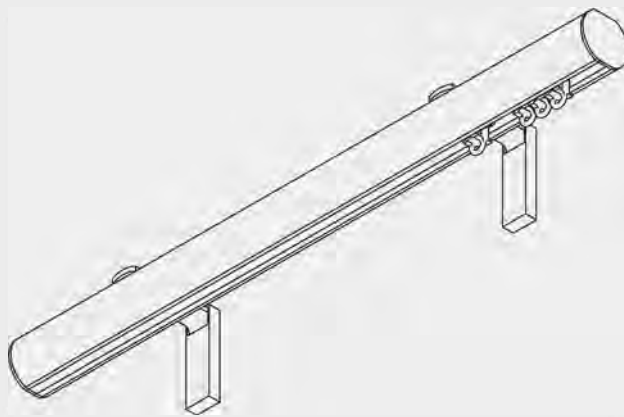

Product Information

- Hand operated system for domestic and contract applications
- Unlike other poles, 6130 can be bent to a small radius for bay windows
- Choice of 5 different finishes - Bronze, Gunmetal, Matt Black, Matt White and Anodised Silver
- Metropole is available with a range of finials offering a contemporary or traditional finish
- Accessorised with matching end caps and co-ordinated or matching brackets/bracket covers
- Easy fitting to wall or ceiling
- For medium to heavy curtains
- Suitable for use with Wave Curtain heading systems
- Custom powdercoating available
- Optional colours available by special order with longer lead times and POA due to air freight costs
- Optional colours available by special order are: Ecu, Antique Bronze, Charcoal, Anodic Grey, Slate Grey, White, Sand, Ochre, Chrome and Taupe.

6130M

Standard Colours



Optional Colours

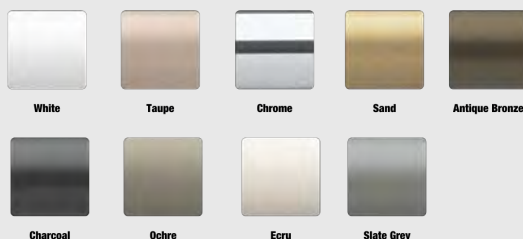

Profile and Bending Information

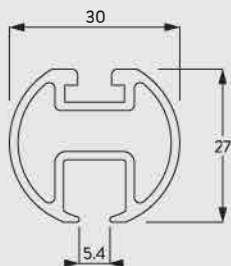

6103



Standard radius 300mm

Specification Guide - download from www.silentgliss.co.uk (password required).

Silent Gliss 6130 curtain track, hand drawn, aluminium, assembled complete with 2C gliders 11301 at 10/m and 2 endcovers 0346 (Flush Fitting End Cap) or 0707 (Stud End Cap). Face fix with brackets 11206-208/11216-218/11209, top fix with bracket 6138P/0335 each screwed to timber/plugged and screwed to block-work/concrete at 600mm centres. Finished in Bronze, Gunmetal, Matt Black, Matt White or Anodised Silver.

How To Measure

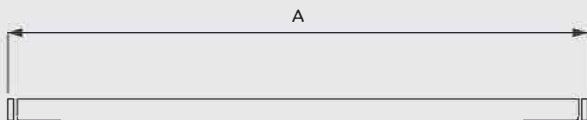

A: System Width - includes finials. See 'Design Options' for finial sizes.

Stack Size Calculation Wave

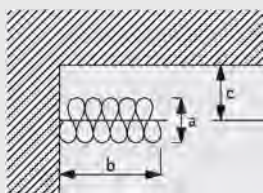

a = Stack depth
b = Stack size
c = Min. distance

Glider-cord spacing	Curtain hook spacing	Approx. curtain fullness	Stack depth (a)	Stack width (b)	Min distance (c)
6	10	2.1	10	23 per metre of track + endpiece	8
6	12	2.3	12	23 per metre of track + endpiece	9
8	14	2.1	14	18 per metre of track + endpiece	10
8	16	2.3	16	18 per metre of track + endpiece	11

Wave standard with roller gliders

Glider-cord spacing	Curtain hook spacing	Approx. curtain fullness	Stack depth (a)	Stack width (b)	Min distance (c)
8	14	2.1	14	21 per metre of track + endpiece	10
8	16	2.3	16	21 per metre of track + endpiece	11

(dimensions in cm)

Note: Minimum distance (c) includes a standard 3cm clearance (front and back).

Design Options

Endaps

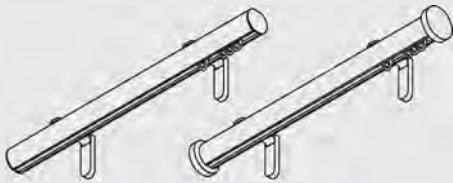

Without finials, poles are supplied as standard with flush fitting endcaps 0346 (left). Alternatively, stud endcaps 0707 (right) can be selected at no additional cost.

Finials

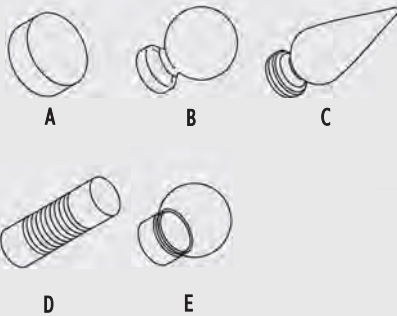

Finials are decorative elements that fit on at the end of the pole.

Please refer to the Metropole brochure for full range details.

A: 0873 Design Endcap 20mm

B: 0556 Ball End 70mm

C: 0719 Spear 135mm

D: 0629 Groove Cylinder 85mm

E: 0331 Glass Ball (clear/frosted) 55mm

Note: Finials are ordered in from the United Kingdom and will require approximately 2 weeks lead time added to our standard manufacturing times (lead time approx. 4 weeks altogether).

6130M

Standard Flush End Cap



Matt White



Matt Black



Silver



Gun Metal



Bronze

Stud End Cap



Matt White



Black



Silver



Gun Metal



Bronze

Design End Cap



Matt White



Matt Black



Anodised Silver



Gunmetal



Bronze

Ball End



Matt White



Matt Black



Anodised Silver



Gunmetal



Bronze

Glass Ball Frosted



Matt White



Matt Black



Anodised Silver



Gunmetal



Bronze

Glass Ball Clear



Matt White



Matt Black



Anodised Silver



Gunmetal



Bronze

Groove Cylinder



Matt White



Matt Black



Anodised Silver



Gunmetal



Bronze

Spear



Matt White



Matt Black



Anodised Silver



Gunmetal



Bronze

Wave Standard curtain heading system

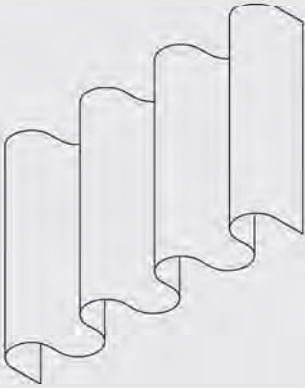

Wave Standard is an exciting contemporary curtain heading system which allows curtains to hang in a continuous wave which is smooth, simple and elegant.

When using the Wave curtain heading system please note the maximum recommended curtain weight is 2.5kg/m or 10kg/m with wave roller glider 6098W.

The Wave standard components are:

- 6345 Glider Cord 60mm
- 6346 Glider Cord 80mm
- 6007 End stop

The items listed below are all supplied at an additional cost as per the price list.

- 2255 Adjustable brake
- Roller gliders must be ordered separately
- 6098W Wave roller glider 80mm

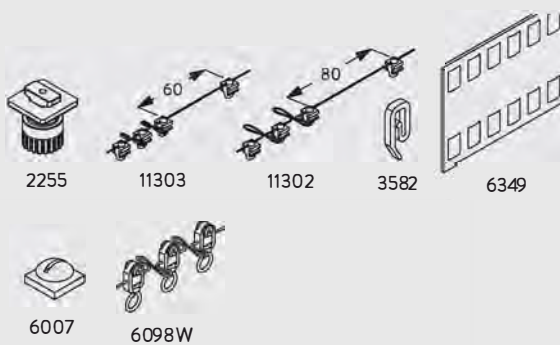

6130M

Fitting Information

Bracket positioning



Fitting of tracks to brackets

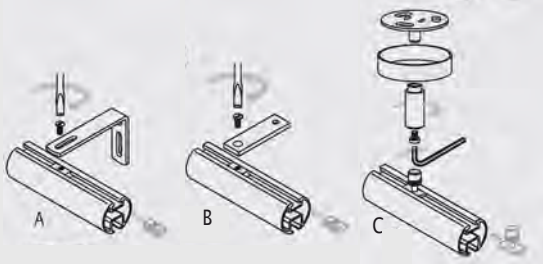

- A: Using bracket sets 11206-11208/11216-11218/11209
- B: Using top fix plates 6138p/6138p2
- C: Using top fix bracket 0335 (Indent order - 4 week lead time)

Note: all bent Metropole systems are supplied with adjustable bracket set 11209 as standard

Fitting bent tracks

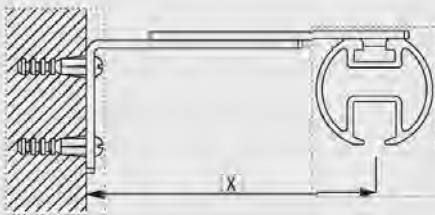

Fitting double tracks

Double brackets available by request. Please use standard smart fix 150mm or 200mm. Please specify inner drill hole location.

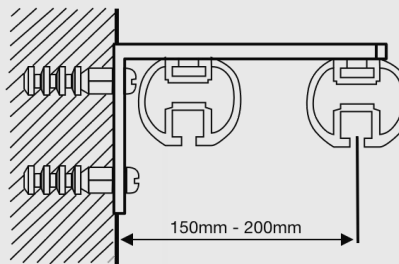

Fitting Options

Ceiling fix with support 6138P

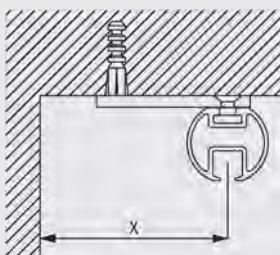

X (mm)
80

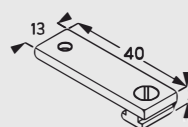

6138p
Ceiling support set
(3mm)

The final distances may be outside of the recommendations above depending on curtain make-up and any obstructions.

Wall fix with adjustable Smartfix bracket 11209

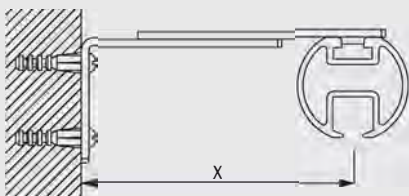

11209 X (mm)
80-100

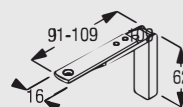

11209
Smart Fix with
extension arm set



6141
Track insert (uses
screw 0798)

Note: all bent Metropole systems are supplied with adjustable bracket set 11209 as standard.

Ceiling fix with top fix bracket 0335 (Indent order - 4 weeks lead time)

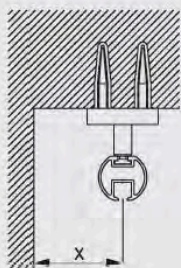

	X (mm)
0335	50



Wall fitting with Smart Fix with slot 11206-11208

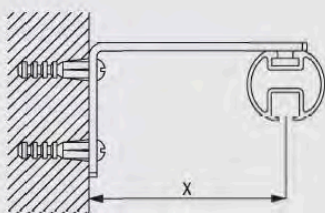

	X (mm)
11206	33-51
11207	53-71
11208	73-91

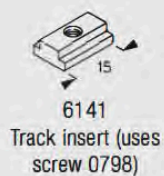
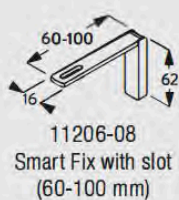

Brackets feature slot for screw M4x8

Wall fitting with Square Smart Fix with slot 11216-11218

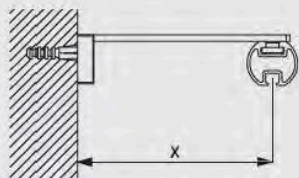

	X (mm)
11216	33-51
11217	53-71
11218	73-91

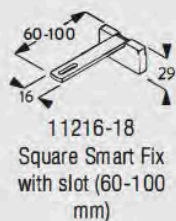

Brackets feature slot for screw M4x8

6130M

Standard Accessories

Parts

0346	Flush endcap (30mm)		6065	Twist eye endstop	
6103	Profile		6141	Track insert (uses screw 0798)	
11301	2C Glider in strip form		6784	Machine screw (for 6141 insert)	
11206	Smart Fix, 60 mm with slot set		11209	Smart Fix with extension arm set	
0707	End cover (30mm)				

Optional Accessories

Parts

0873	Design Endcap 30mm				
0331	Glass ball (30mm)		0556	Ball end finial (30 mm)	
0335	Top fix bracket (indent only - 4 weeks lead time)		2255	Adjustable Brake	
0629	Groove Cylinder (30mm)		0719	Spear finial	
0770	Finial connecting bracket		6283	Roller glider	
6635	Internal connecting bridge assembly		11207	Smart Fix, 80 mm with slot set	
11208	Smart Fix, 100 mm with slot set		11209	Smart Fix with extension arm set	
11216	Square Smart Fix, 60 mm with slot set		11217	Square Smart Fix, 80 mm with slot set	
11218	Square Smart Fix, 100 mm with slot set		6138p	Ceiling support set (3mm)	
3582	Hook		6007	Endstop	
11303	2C Wave glider cord (60mm)		11302	2C Wave glider cord (80mm)	
6349	Curtain tape		6098W	Wave roller glider cord (80mm)	

6130M



www.silentgliss.com.au



Q U A L I T Y + D E S I G N E X C E L L E N C E

Contact Blinds by Peter Meyer

Head Office & Australian Showroom
25 Richmond Road, Homebush NSW 2140 Australia.
FREECALL: 1800 254 631
Email: sales@petermeyerblinds.com.au
Trade Enquiries: (02) 8762 1900