

SG 6010

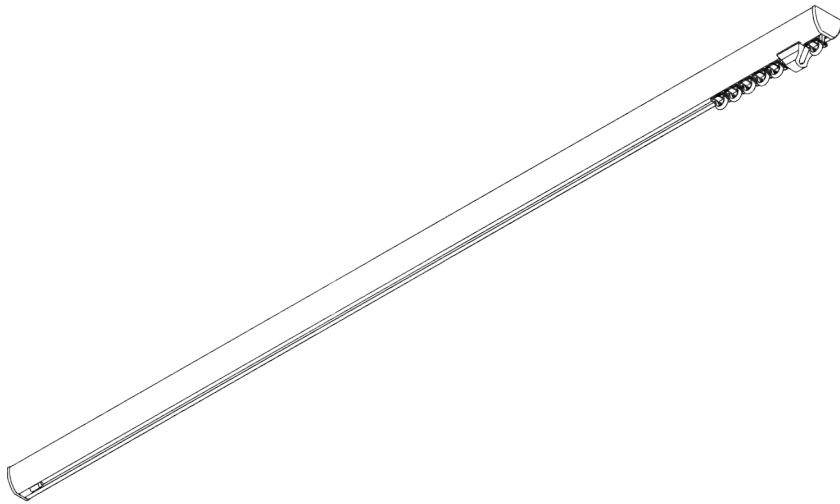
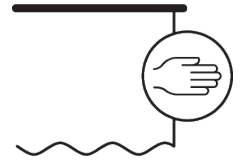

PRODUCT INFORMATION

- **Operation:** hand
- **Range:** S - M
- **Fitting:** ceiling, wall
- **Colours:** white RAL 9016; special colours or anodised aluminum possible
- **Fabrics:** refer to Silent Gliss fabric collection

Features:

- 2-component (2C) glider technology
- Wave (2C)
- Bendable

SYSTEM SPECIFICATIONS

A. PROFILE

Profile and bending information

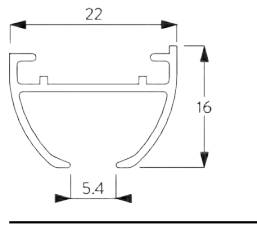

SG 6010p

Profile

Radius:
✓ 15 cm, >25 cm

B. HOW TO MEASURE

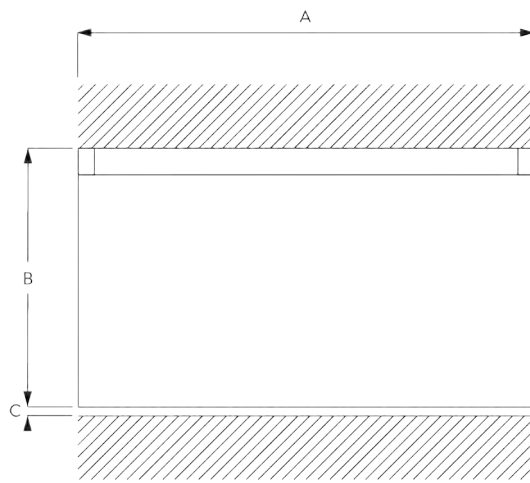

A: System width

B: System height

C: Distance between floor and fabric

C. SPECIFICATION

TEXT

Silent Gliss SG 6010 Hand Operated Curtain Track System. Comprises aluminium profile SG 6010p supplied made to measure powder coated in white. Supplied as standard with 2C gliders SG 11301 at 16/m, 2 end covers SG 6018 and 2 end stops SG 6007. Top fixed with clamp SG 3825 at 500mm centres. Wall fix with SG Smart Fix brackets SG 11201-11205 and SG 3832 or SG 3825 / SG Square Smart Fix brackets SG 11210-11215 and SG 3832 or SG 3825 / Universal Smart Fix brackets SG 11154-11156 and SG 3832 or SG 3825. Silent Gliss Wave option is available using 60mm glider cord SG 11303 / 80mm glider cord SG 11302.

FITTING

A. FITTING INFORMATION

Fixing points

For detailed fitting information, visit the [Silent Gliss website](#).

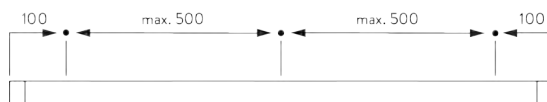

B. CEILING FITTING

Clamp SG 3825

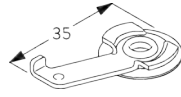
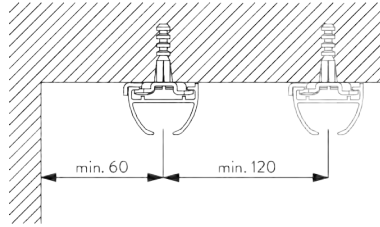

SG 3825

Clamp

Bracket SG 3832

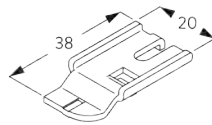
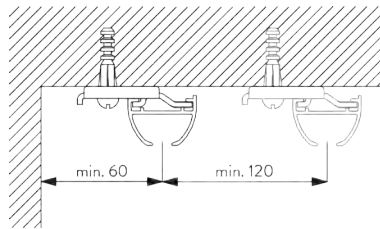

SG 3832

Bracket

C. WALL FITTING

Smart Fix

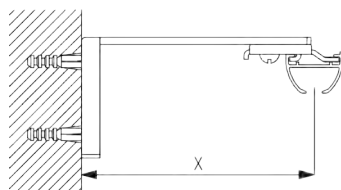

Smart Fix SG 11200 - SG 11205 and bracket SG 3832:
Screw (M4x8) needed.

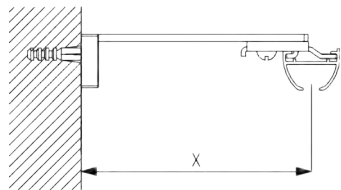

Square Smart Fix SG 11210 - SG 11215 and bracket SG 3832:
Screw (M4x8) needed.

Smart Fix	X mm (SG 3832)	X mm (SG 3825)
SG 11200 / SG 11210	70	52
SG 11201 / SG 11211	90	72
SG 11202 / SG 11212	110	92
SG 11203 / SG 11213	130	112
SG 11204 / SG 11214	160	142
SG 11205 / SG 11215	210	192
SG 11154	120-148	102-130
SG 11155	150-178	132-160
SG 11156	200-228	182-210

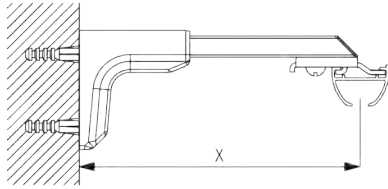

Universal Smart Fix SG 11154 - SG 11156 and bracket SG 3832:
Screw (M4x10) needed.

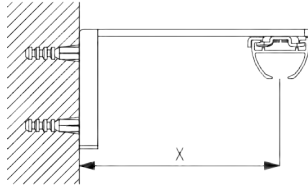

Smart Fix SG 11200 - SG 11205 and clamp SG 3825:
Screw (M4x8) needed.

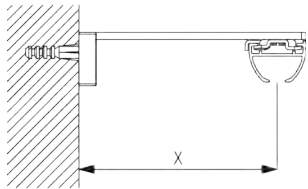

Square Smart Fix SG 11210 - SG 11215 and clamp SG 3825:
Screw (M4x8) needed.

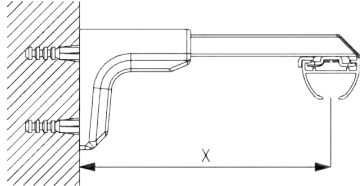

Universal Smart Fix SG 11154 - SG 11156 and clamp SG 3825:
Screw (M4x12) needed.

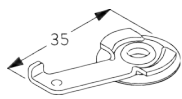

SG 3825
Clamp

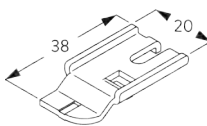

SG 3832
Bracket



Pan head screw M4x10



Pan head screw M4x8



Countersunk head screw M4x12

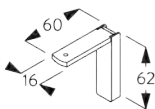

SG 11200
Smart Fix 60 mm

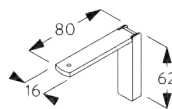

SG 11201
Smart Fix 80 mm

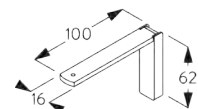

SG 11202
Smart Fix 100 mm

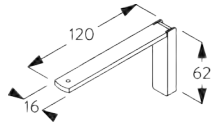

SG 11203
Smart Fix 120 mm

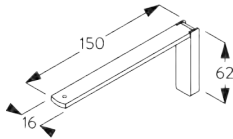

SG 11204
Smart Fix 150 mm

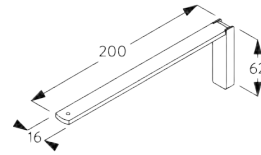

SG 11205
Smart Fix 200 mm

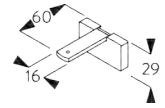

SG 11210
Square Smart Fix 60 mm

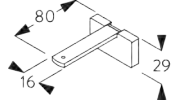

SG 11211
Square Smart Fix 80 mm

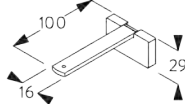

SG 11212
Square Smart Fix 100 mm

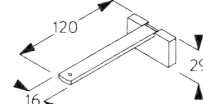

SG 11213
Square Smart Fix 120 mm

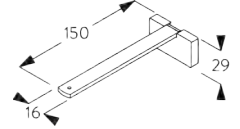

SG 11214
Square Smart Fix 150 mm

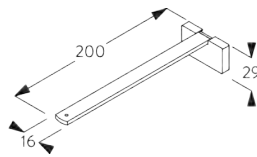

SG 11215
Square Smart Fix 200 mm

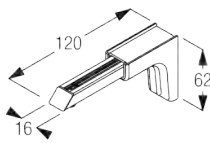

SG 11154
Universal Smart Fix 120 mm

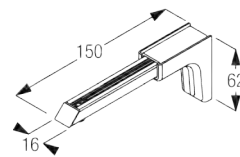

SG 11155
Universal Smart Fix 150 mm

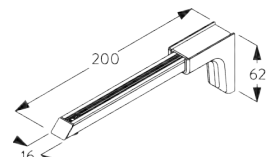

SG 11156
Universal Smart Fix 200 mm

SYSTEM OPTIONS

A. WAVE

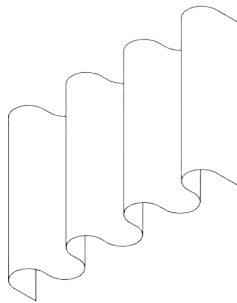

SG 6007

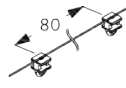

SG 11302

Standard components:

- SG 6007 End stop
- SG 11302 Wave 2C glider cord 80 mm

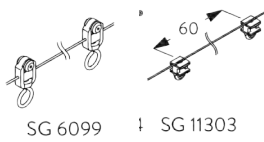

Optional components (min. radius: >25 cm):

- SG 6099 Wave roller cord 80 mm
- SG 11303 Wave 2C glider cord 60 mm

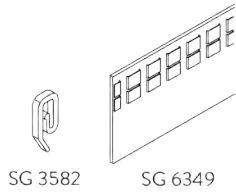

Curtain components:

- SG 3582 Hook
- SG 6349 Wave curtain tape

Wave stack depth - 2C glider cord (standard components)

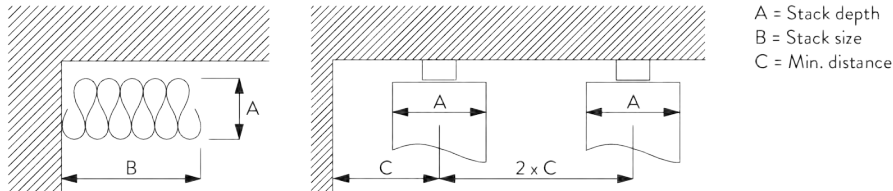

A = Stack depth
B = Stack size
C = Min. distance

2C Glider cord SG 11302	Pockets between hooks	Approx. curtain fullness	Stack depth A	Stack size B*	Min distance C
80	6	~2.1	140	180 per metre of track	90
80	7	~2.3	160	180 per metre of track	100

2C Glider cord SG 11303	Pockets between hooks	Approx. curtain fullness	Stack depth A	Stack size B*	Min distance C
60	4	~2.1	100	230 per metre of track	70
60	5	~2.3	120	230 per metre of track	80

GENERAL NOTES

Dimensions

- Measurements are in mm except where indicated.
- Max. kg relates to fabric incl. accessories.
- Stack size depends on curtain make-up and fabric thickness.
- Distance between gliders max. 80 mm / distance between rollers max. 100 mm.
- Recommended distance floor / fabric: 20 mm.
- In order to determine system height (B), the smallest room height must be taken into account.

Fitting



- Installation by qualified fitter only.
- Number of brackets and fitting positions / fixing points vary depending on fitting surface, system weight, fabric make-up, screw / fixing type and obstacles.
- Qualified fitter must use appropriate screws / fixings for each situation.
- Profile lip if applicable to be installed to room side.

Child Safety





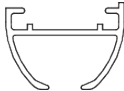
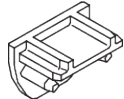
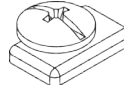





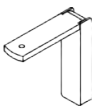
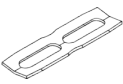
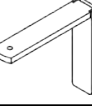
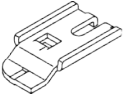

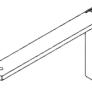

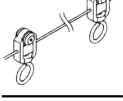
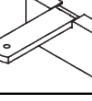

- All relevant Silent Gliss systems correspond to child safety EN 13120.
- All parties involved must comply with EN 13120.

PARTS

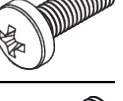
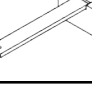
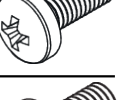
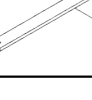
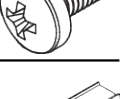
A. STANDARD PARTS

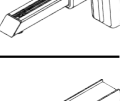
	SG 3825 Clamp
	SG 6010p Profile
	SG 6018 End cover
	SG 6007 End stop
	SG 11301 2C glider on strip

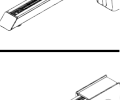
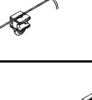
B. OPTIONAL PARTS

	SG 3582 Hook		SG 11200 Smart Fix 60 mm
	SG 3802 Connection bridge		SG 11201 Smart Fix 80 mm
	SG 3832 Bracket		SG 11202 Smart Fix 100 mm
	SG 6064 End stop		SG 11203 Smart Fix 120 mm
	SG 6086 Spring stop		SG 11204 Smart Fix 150 mm
	SG 6098 Roller		SG 11205 Smart Fix 200 mm
	SG 6099 Wave roller cord 80 mm		SG 11210 Square Smart Fix 60 mm
	SG 6283 Roller		SG 11211 Square Smart Fix 80 mm
	SG 6349 Wave curtain tape		SG 11212 Square Smart Fix 100 mm
	Pan head screw M4x12		SG 11213 Square Smart Fix 120 mm
	Pan head screw M4x10		SG 11214 Square Smart Fix 150 mm
	Pan head screw M4x8		SG 11215 Square Smart Fix 200 mm
	SG 11154 Universal Smart Fix 120 mm		SG 6065 End stop
	SG 11155 Universal Smart Fix 150 mm		SG 11302 Wave 2C glider cord 80 mm
	SG 11156 Universal Smart Fix 200 mm		SG 11303 Wave 2C glider cord 60 mm

