

# SG 7605

---

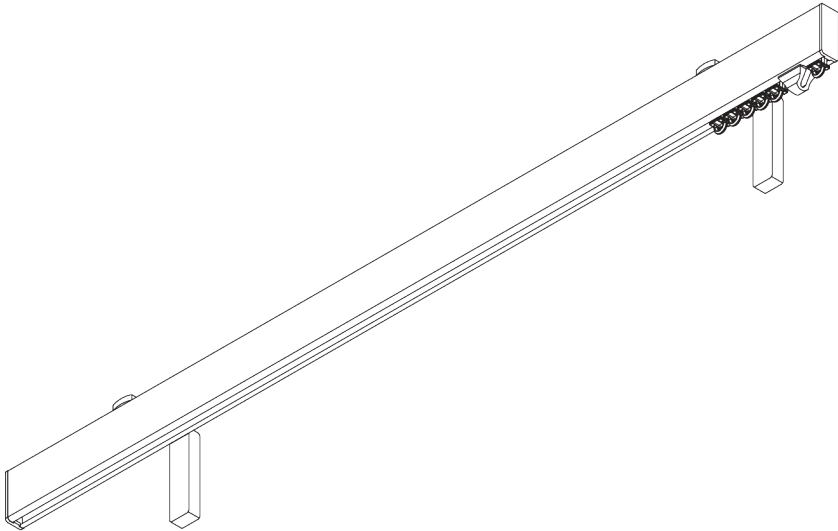
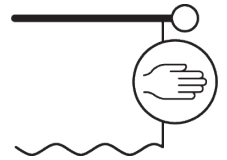

## PRODUCT INFORMATION

- **Operation:** hand
- **Range:** S - M
- **Fitting:** ceiling, wall
- **Colours:** white RAL 9016, various colours / finishes

### **Features:**

- 2-component (2C) glider technology
- Wave (2C)
- Matching endcaps and brackets / bracket covers
- Bendable

# SYSTEM SPECIFICATIONS

## A. PROFILE

Profile and bending information

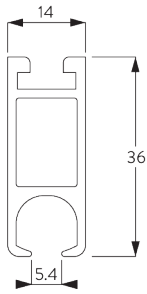

**SG 6101**

Profile

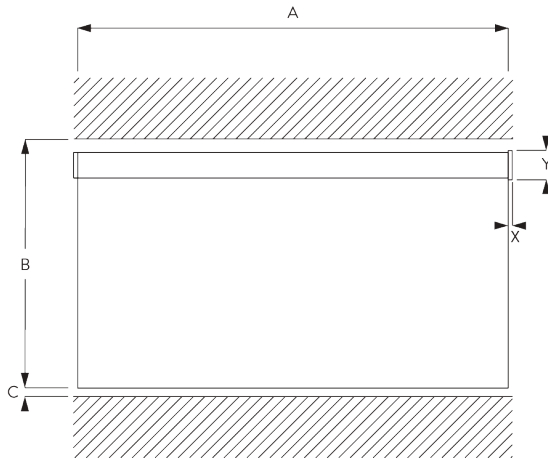

Radius:  
20 cm, >25 cm

## B. HOW TO MEASURE



A: System width without endcaps  
B: System height  
C: Distance between floor and fabric  
X: Endcap width  
Y: Endcap height

## Endcap Measurements

		36 mm	
		X	Y
	SG 11601	2	36
	SG 11611	5	40

## C. SPECIFICATION TEXT

**Silent Gliss SG 7605 'Metropole' hand operated curtain track system.** Comprises 36mm h x 14 mm d aluminium profile SG 6100 supplied made to measure with 2C gliders SG 11300 at 16/m, 2 end flush covers SG 11601 and 2 no. end stops SG 6065. Straight poles supplied as standard with wall 'face' fix Smart Fix brackets SG 11206 at max. 600 mm centres. Optional wall fix brackets SG 11207-11208 / SG 11216-11218 / SG 11209 / SG 11472. Bent systems for wall 'face' fix supplied as standard with adjustable Smart Fix bracket SG 11209. Ceiling 'top' fix with plate SG 6151 / bracket SG 6175 / SG 11668 at max. 600 mm centres. Finished in Black and Matt White. A range of decorative finials are available. Silent Gliss Wave option is available using 60mm glider cord SG 11303/80 mm glider cord SG 11302 / 80 mm roller glider cord SG 6099.

# FITTING

## A. FITTING INFORMATION

For detailed fitting information, visit the Silent Gliss website.

### Fixing points

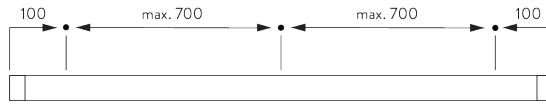

## B. CEILING FITTING

### Support SG 6151

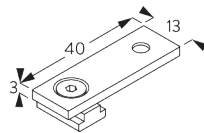
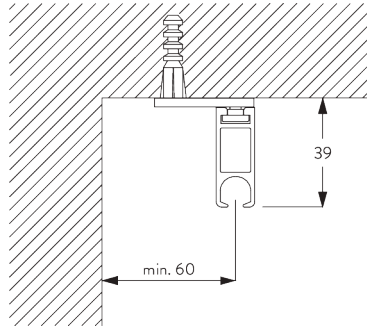

**SG 6151**

Ceiling support set 3 mm

### Top fix bracket SG 11668

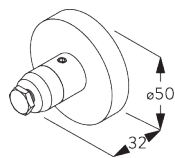
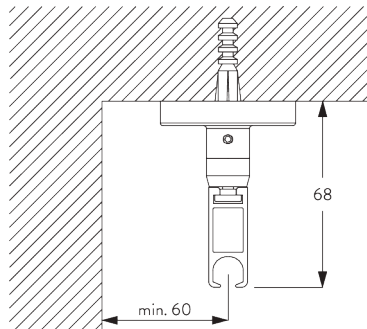

**SG 11668**

Top fix bracket

## Mini hanger SG 6175

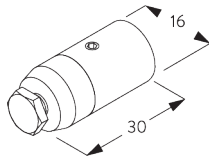
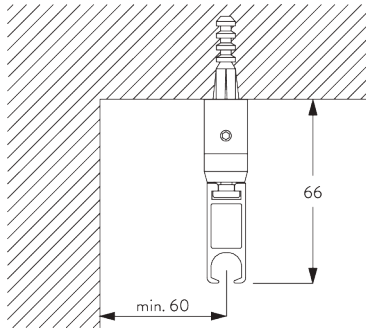

**SG 6175**

Mini hanger

## C. WALL FITTING

### Smart Fix

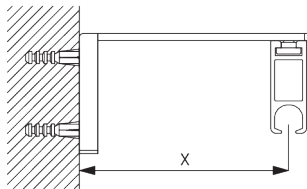

**Smart Fix with slot SG 11206 - SG 11208 and SG 6141:**

Smart Fix	X mm
SG 11206 / SG 11216	51
SG 11207 / SG 11217	71
SG 11208 / SG 11218	91
SG 11209 / SG 11472	80-100

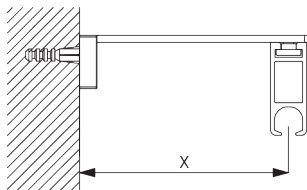

**Square Smart Fix with slot SG 11216 - SG 11218 and SG 6141:**

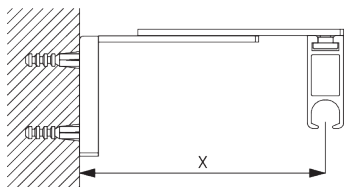

**Adjustable Smart Fix SG 11209 and SG 6141:**

Note: all bent Metropole systems are supplied with adjustable bracket SG 11209 as standard.

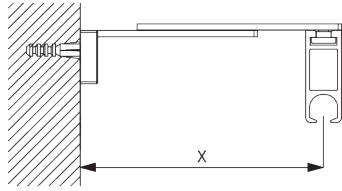

**Adjustable Square Smart Fix SG 11472 and SG 6141:**

Screw SG 6784 (M4x8) needed.

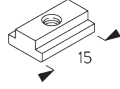

**SG 6141**

Clamping piece

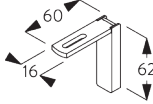

**SG 11206**

Smart Fix with slot 60 mm

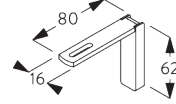

**SG 11207**

Smart Fix with slot 80 mm

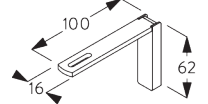

**SG 11208**

Smart Fix with slot 100 mm

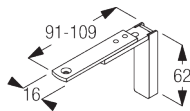

**SG 11209**

Adjustable Smart Fix

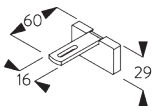

**SG 11216**

Square Smart Fix with slot 60 mm

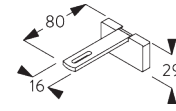

**SG 11217**

Square Smart Fix with slot 80 mm

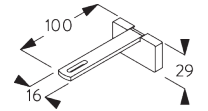

**SG 11218**

Square Smart Fix with slot 100 mm

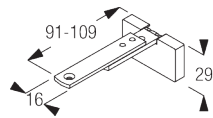

**SG 11472**

Adjustable Square Smart Fix

**Fillet Bracket  
SG 11669**

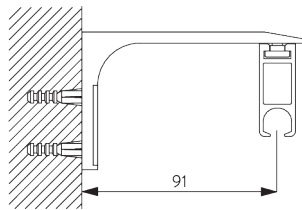

Screw SG 6784 (M4x8) needed.

Recommended for straight systems only.

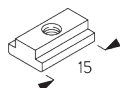

**SG 6141**

Clamping piece



**SG 6784**

Hexagon socket countersunk screw M4x8 mm

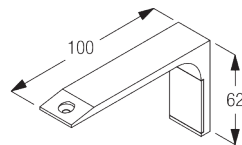

**SG 11669**

Fillet bracket

**Maxi adjustable  
bracket SG 20334**

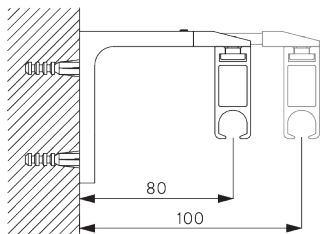

Screw SG 6783 (M4x10) needed.

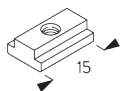

**SG 6141**  
Clamping piece



**SG 6783**  
Hexagon socket countersunk  
screw M4x10 mm

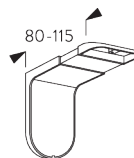

**SG 20334**  
Maxi adjustable bracket

# DESIGN & SYSTEM OPTIONS

## A. ENDCAPS



SG 11601



SG 11611

Please note:

- Poles are supplied as standard with flush fitting endcaps SG 11601 (left).
- Alternatively, stud endcaps SG 11611 (right) can be selected at no additional cost.

## B. WAVE

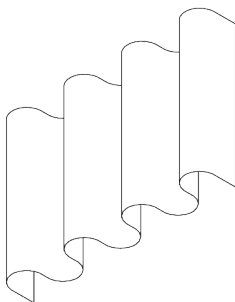

SG 11295

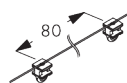

SG 11302

Standard components:

- SG 11295 End stop
- SG 11302 Wave 2C glider cord 80 mm



Optional components (min. Radius >25 cm):

- SG 2256 Brake
- SG 6099 Wave roller cord 80 mm
- SG 11303 Wave 2C glider cord 60 mm

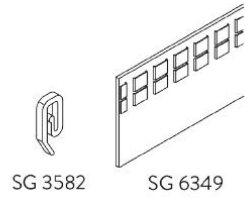

Curtain components:

- SG 3582 Hook
- SG 6349 Wave curtain tape

Wave stack depth - 2C glider cord (standard components)

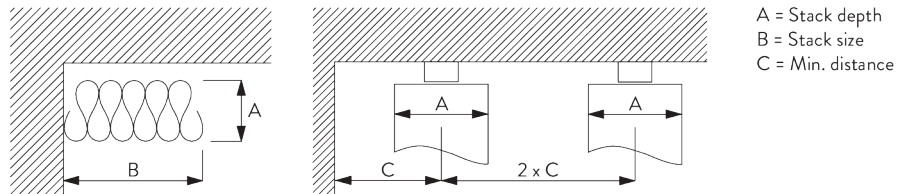





2C Glider cord SG 11302	Pockets between hooks	Approx. curtain fullness	Stack depth A	Stack size B*	Min distance C
80	6	~2.1	140	180 per metre of track	90
80	7	~2.3	160	180 per metre of track	100

2C Glider cord SG 11303	Pockets between hooks	Approx. curtain fullness	Stack depth A	Stack size B*	Min distance C
60	4	~2.1	100	230 per metre of track	70
60	5	~2.3	120	230 per metre of track	80



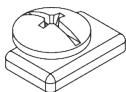

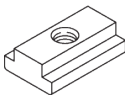
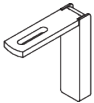

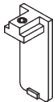



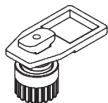
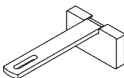

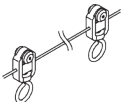
\*Stack size B when using optional extension arm SG 6364 increases by 95 mm per curtain stack!

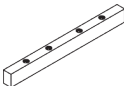
# PARTS

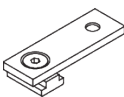
## A. STANDARD PARTS

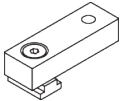
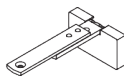
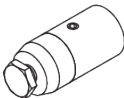
	<b>SG 11295</b> End stop
	<b>SG 6101</b> Profile
	<b>SG 6141</b> Clamping piece
	<b>SG 11206</b> Smart Fix with slot 60 mm
	<b>SG 11300</b> 2C glider
	<b>SG 11601</b> Flush end cap 36 mm

## B. OPTIONAL PARTS

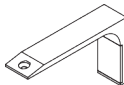
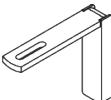
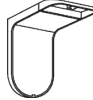
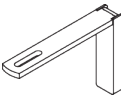
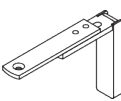
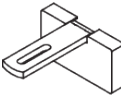
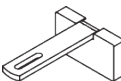
	<b>SG 2256</b> Brake		<b>SG 11218</b> Square Smart Fix with slot 100 mm
	<b>SG 3582</b> Hook		<b>SG 6065</b> End stop
	<b>SG 6099</b> Wave roller cord 80 mm		<b>SG 11301</b> 2C glider on strip
	<b>SG 6112</b> Connection bridge		<b>SG 11302</b> Wave 2C glider cord 80 mm
	<b>SG 6151</b> Ceiling support set 3 mm		<b>SG 11303</b> Wave 2C glider cord 60 mm
	<b>SG 6152</b> (Indent) Ceiling support set 9 mm		<b>SG 11472</b> Adjustable Square Smart Fix
	<b>SG 6175</b> (Indent) Mini hanger		<b>SG 11611</b> Stud end cap 36 mm
	<b>SG 6283</b> Roller		<b>SG 11668</b> (Indent) Top fix bracket
	<b>SG 6349</b> Wave curtain tape		<b>SG 11669</b> (Indent) Fillet bracket - Indent
	<b>SG 11207</b> Smart Fix with slot 80 mm		<b>SG 20334</b> (Indent) Maxi adjustable bracket
	<b>SG 11208</b> Smart Fix with slot 100 mm		
	<b>SG 11209</b> Adjustable Smart Fix		
	<b>SG 11216</b> Square Smart Fix with slot 60 mm		
	<b>SG 11217</b> Square Smart Fix with slot 80 mm		